

Power Analyser

UMG 20 CM

Residual current monitoring (RCM)

Operating instructions and
technical data

Janitza electronics GmbH
 Vor dem Polstück 1
 D-35633 Lahnau
 Support tel. 0049 6441 9642-22
 Fax 0049 6441 9642-30
 E-mail: info@janitza.de
 Internet: <http://www.janitza.com>

Janitza®

Table of contents

General	4		
Copyright	4	Unearthed three-phase, 3-conductor system (230 V L-L)	13
Trademarks	4	Residual current monitoring	13
Disclaimer	4	Application examples	14
Comments on the manual	4	Functional description	18
Meaning of the symbols	4	General functions	18
Instructions for use	5	Measuring function	22
Concerning these operating instructions	6	Transformer connection monitoring	23
Inspection on receipt	6	Limit value monitoring	23
Scope of delivery	7	Storing extreme values	24
Device design	8	Installation	24
Device view	8	Position of installation	24
Device dimensions	8	Mounting	24
Labels	8	Installation	24
Product description	9	Supply voltage	24
Proper use	9	Voltage measurement inputs	25
The UMG 20 CM performance features	10	Voltage and current measurement	27
The system power supply without drop-outs	11	Residual current measurement	32
Measuring process	12	RS485 interface	32
Operating concept	12	Bus structure	32
GridVis programming software	12	Termination resistors	32
Earthed three-phase, 4-conductor system (230 V L-N)	12	Screening	32
Earthed three-phase, 3-conductor system (400 V L-L)	13	Connection	33
		Cable type	33
		Cable length	33
		Digital outputs	33

Putting into service	34
RS485 interface	34
Applying the measuring-circuit voltage	34
Connecting the supply voltage	35
Display and control elements	36
General meaning of the LED colours and signals	36
Meaning of the LEDs	36
The service button functions	39
Configuration	40
RS485 interface	40
Technical data	41
UMG 20 CM technical data	41
Function parameters	44
Technical data for the usable current transformer	47
Declaration of conformity	52
Brief instruction	54
Connection example	58

General

Copyright

This operating manual is subject to the legal requirements for copyright protection and may not be, either in whole or in part, photocopied, reprinted, or reproduced by mechanical or electronic means, or in any other manner be duplicated or redistributed without the legally binding, written agreement of

Janitza electronics GmbH, Vor dem Polstück 1,
D 35633 Lahnau, Germany.

Trademarks

All trademarks and their resulting rights belong to the respective holders of these rights.

Disclaimer

Janitza electronics GmbH takes no responsibility for errors or defects within this operating manual and takes no responsibility for keeping the contents of this operating manual up to date.

Comments on the manual

We welcome your comments. In the event that anything in this manual seems unclear, please let us know and send an e-mail to: info@janitza.de

Meaning of the symbols

The following pictograms are used in this operating manual:



Warning!

Dangerous voltage! Danger to life or risk of serious injury. Disconnect system and device from power supply before beginning work on them.



Caution!

Please observe the documentation. This symbol warns of possible dangers that can arise during installation, commissioning and use.



Note!

Instructions for use

Please read the operating manual at hand as well as all other publications that must be drawn from for working with this product (in particular for the installation, operation or maintenance).

Follow all safety regulations and warning information. If you do not follow the information, it can result in bodily injury and/or damage to the product.

Any unauthorised changes or use of this device, which go beyond the mechanical, electrical or otherwise stated operating limitations, can result in bodily injury or/and damage to the product.

Any of such unauthorized changes constitute "misuse" and/or "negligence" in terms of the warranty for the product and therefore eliminates the warranty for covering any potential damage resulting from this.

This device is to be operated and maintained exclusively by specialized personnel.

Specialized personnel are persons, that based on their respective training and experience, are qualified to recognize risks and prevent potential dangers that can be caused by the operation or maintenance of the device.

Additional legal and safety regulations required for the respective application are to be following during the use of the device.



Warning!

If the device is not operated according to the operating manual, protection is no longer ensured and hazards can be presented by the device.



Caution!

Single core wires must be provided with sleeves.



Caution!

Only pluggable screw terminals with the same number of poles and the same type of construction are permitted to be connected together.

Concerning these operating instructions

These operating instructions are part of the product.

- Read the operating instructions before using the device.
- Keep the operating instructions throughout the entire service life of the product and have them readily available for reference.
- Pass the operating instructions on to each subsequent owner or user of the product.



Note!

All screw-type terminals included in the scope of delivery are attached to the device.

Inspection on receipt

The prerequisites of faultless, safe operation of this device are proper transport and proper storage, set-up and assembly, as well as careful operation and maintenance.

Packing and unpacking must be carried out with customary care without the use of force and only using suitable tools. The devices should be visually checked for flawless mechanical condition.

If it can be assumed that risk-free operation is no longer possible, the unit must be immediately put out of operation and secured against being put back into operation again.

It can be assumed that risk-free operation is no longer possible if the device, for example,

- has visible damage
- no longer works despite the mains power supply being intact
- has been exposed to prolonged adverse conditions (e.g. storage outside the permissible climate limits without being adapted to the room climate, condensation, etc.) or rough handling during transportation (e.g. falling from a height, even if there is no visible external damage, etc.)

Please check the delivered items for completeness before you start installing the device.

Scope of delivery

Number	Part no.	Description
1	14.01.625	UMG 20 CM
1	33.03.311	Operator's Manual in English
1	51.00.116	CD with following content: <ul style="list-style-type: none">• GridVis programming software• GridVis functional description
1	14.01.632	Complete connector set

Device design

Device view

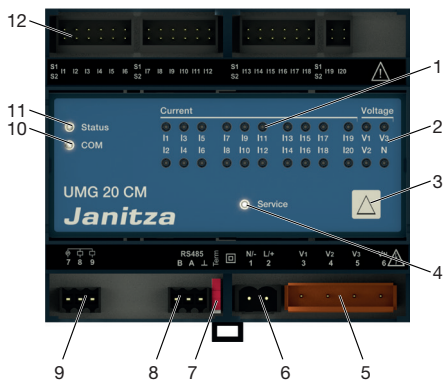

Fig. device view UMG 20 CM

- | | |
|------------------------------|---|
| 1 Measuring channels LEDs | 7 Switch for bus termination resistor |
| 2 Supply voltage LEDs | 8 RS485 interface connection |
| 3 Service button | 9 Digital outputs |
| 4 "Service" LED | 10 "COM" LED |
| 5 Voltage measurement inputs | 11 "Status" LED |
| 6 Supply voltage connection | 12 Current measurement transformer connection |

Device dimensions

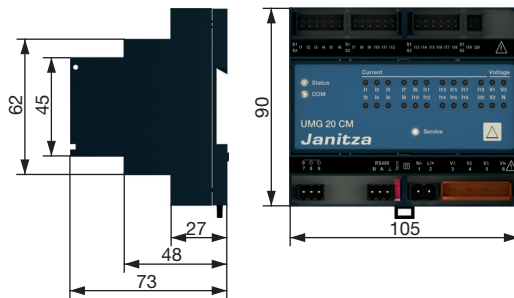

Fig. device dimensions

Dimensions provided in mm

Labels

A rating plate with the manufacturer, serial number and item number is attached to the device:



Product description

Proper use

The UMG 20 CM is intended for the measurement and calculation of electrical parameters such as voltage, current, power, energy, harmonics, etc. in building installations, on distribution units, circuit breakers and busbar trunking systems.

The device is suitable for installation in fixed switch cabinets and installation distributors. It can be installed in any mounting position.

Measured voltage and measured currents must derive from the same network.

The device is designed for use in industrial and residential areas.

The voltage measurement inputs are designed for measurements in earthed low voltage networks with a L-N rated voltage of 230 V and in unearthed networks with a L-L rated voltage of 230 V. Surge voltages relative to earth of overvoltage category III (CAT III) may occur.

The current measurement inputs are designed for the connection of current transformers with a secondary current of max. 100 mA.

When measuring operating currents (load currents), the current transformers are provided with an external load resistance. The residual currents are measured without an external load resistance.

A current measurement input may be permanently overloaded with 1 A.

Due to their a joint reference, the current measurement inputs are only switched according to the connection schematic in this manual (see page 28 to 31). Two current measurement inputs cannot be connected in series, for example.



Caution!

The residual current monitoring function of the UMG 20 CM may only be used for reporting purposes. The device is not an independent protective device.

The UMG 20 CM performance features

General

- Measurement in TN and TT networks
- 4 Voltage measurement inputs (300 V CAT III)
- 20 Current measurement inputs
- RS485 interface (Modbus[®] RTU/slave)
- 2 Digital outputs
- Monitoring the currents for compliance with adjustable threshold values
- Generation of warning and triggering messages if the threshold value is exceeded
- Indication of the threshold value monitoring status with 20 LEDs
- Transformer connection monitoring for residual current measurement
- Assembly on top-hat rails 35 mm (4 TE)
- Suitable for installation in installation distributors
- Continuous sampling of the voltage and current measurement inputs
- Sampling frequency 20 kHz
- Working measurement, measurement uncertainty class 1 (IEC/EN 61557-12)

Measurement and calculation

- Network star and outer conductor voltages
- Consumer operating currents
- Mains frequency
- Quantity and phase angle of the basic oscillations of voltages and currents
- Effective, reactive and apparent power
- Effective power
- Power factor
- $\cos(\phi)$
- Crest factor of voltages and currents
- Harmonic distortion of voltages and currents
- 1st to 63rd harmonic of voltages and currents
- Consumer leakage currents

Saving the minimum and maximum values with time stamp

- Apparent power
- Effective power
- Total of effective power and consumption of any current inputs

The system power supply without drop-outs

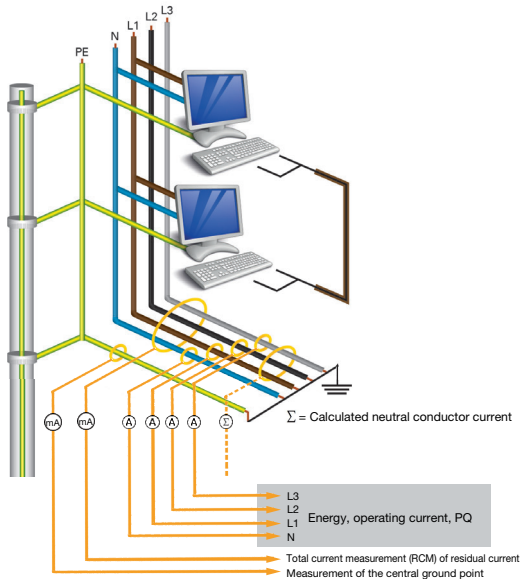

TN-S systems are mandatory with new systems. In the case of older TN-C-S systems, upgrading to TN-S is recommended. The functionality of TN-S systems can be permanently monitored and recorded with Janitza RCM solutions.

This requirement constitutes a key function in many industries and application areas for the safety and economic success of the company.

The RCM employed here should be easy to use, automatically highlight any problems and offer the service technician valuable assistance at the same time.

Message before drop-out

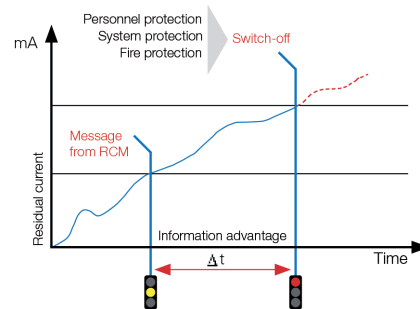

Measuring process

The UMG 20 CM continuously measures effective values, performance, etc. The settling time constant of the measured values is 0.2 s. The measured values are updated every 10 ms. The UMG 20 CM calculates the characteristic data for the waveform using an analysis channel. The analysis channel can be programmed on a voltage and current channel to calculate the harmonic distortion, crest factor and harmonics. The calculation is carried out cyclically every 100 ms based on the sampled values of a mains period.

Operating concept

The UMG 20 CM is only programmed and read out via the RS485 interface.

The device address is directly set by a button and displayed using LEDs.

GridVis programming software

The UMG 20 CM can be programmed and read out using the GridVis programming software included in the scope of delivery. To do this, the device must be connected to a PC via the RS485 interface.

GridVis features:

- Programming the UMG 20 CM
- Saving data to a database
- Graphical representation of measured values

Earthed three-phase, 4-conductor system (230 V L-N)

The UMG 20 CM can be used in three-phase, 4-conductor systems (TN, TT networks) (50 Hz, 60 Hz) with an earthed neutral conductor. The bodies of the electrical system are earthed.



Caution!

The conductor to the neutral conductor voltage may be max. 300 V AC.

The device is only suitable for environments in which the measurement surge voltage does not exceed 4 kV (CAT III).

Earthed three-phase, 3-conductor system (400 V L-L)

The UMG 20 CM can be used in three-phase, 3-conductor systems (50 Hz, 60 Hz) with an earthed star point. The bodies of the electrical system are earthed.

**Caution!**

Die conductor to the earth voltage may be max. 300 V AC.

The device is only suitable for environments in which the measurement surge voltage does not exceed 4 kV (CAT III).

Unearthed three-phase, 3-conductor system (230 V L-L)

The UMG 20 CM can be used in three-phase, 3-conductor systems (IT network).

**Caution!**

The conductor to conductor voltage may be max. 300 V AC (50 Hz, 60 Hz).

The device is only suitable for environments in which the measurement surge voltage does not exceed 4 kV (CAT III).

The star point of the voltage generator is not earthed in the IT network. The bodies of the electrical system are earthed. Earthing over a high ohmic impedance is permitted. IT networks are only allowed in specific systems with a separate transformer or generator.

**Note!**

Each UMG 20 CM unit connected to the network creates a high ohmic impedance of 440 k Ω against earth through its voltage measurement connections.

The trigger value of the insulation monitoring devices connected to the network must be set correspondingly low.

Residual current monitoring

The UMG 20 CM can be used for measuring residual current sensitive to pulsating currents (type A-RCM). It monitors the residual current transformer's secondary current circuit for interruptions and short circuits. Smooth direct current cannot be measured.

A trigger value between 10 mA and 1 A can be set for each current measurement input and a warning threshold can be set for the respective residual current messages.

Application examples

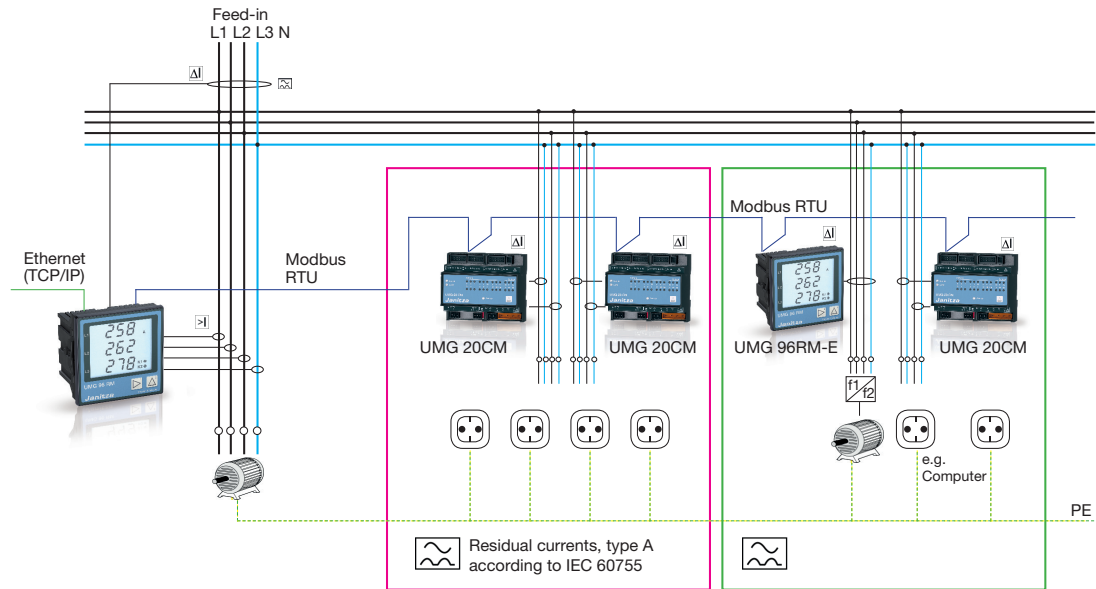

Fig. Comprehensive RCM, operating current monitoring and energy measurement

Typical application cases

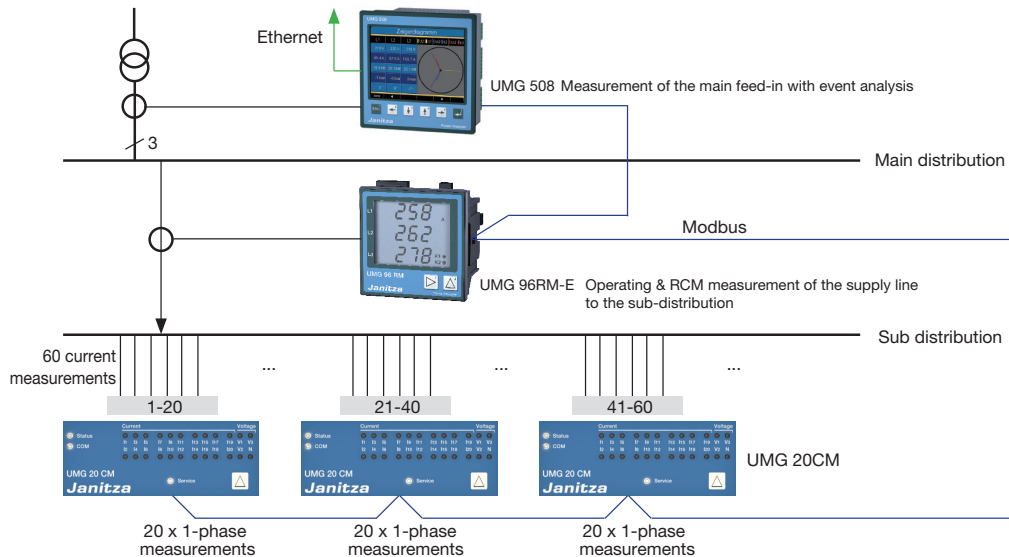

Fig. case 1: Measurement of 60 single-phase current paths, e.g. server racks, apartments or offices

Customer benefits:

Extremely compact solution for complete monitoring via three levels with leading-edge master-slave communication architecture.

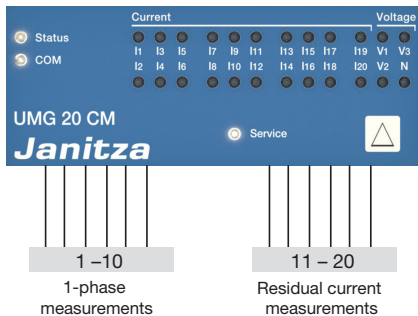

Fig. case 2: 10 single-phase operating current measurements, 10 single-phase residual current measurements

Customer benefits:
Flexible combination of operating current measurement and RCM measurement in a single measurement device.

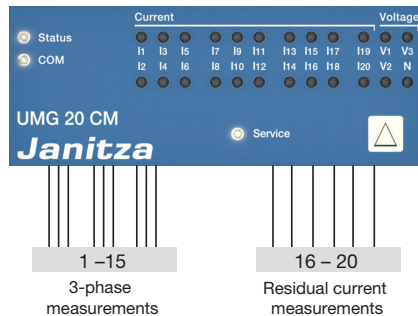

Fig. case 3: 5 three-phase operating current measurements, 5 single-phase residual current measurements

Customer benefits:
Flexible combination of 1-phase and 3-phase measurements in a single measurement device.

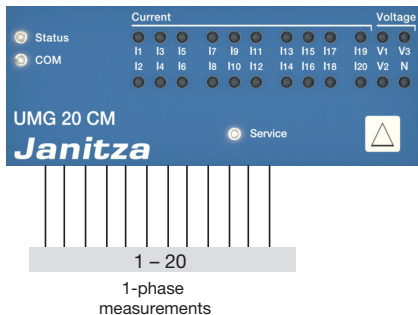

Fig. case 4: 20 single-phase operating current or RCM measurements

Customer benefits:

Very compact measurement device with 20 current measurement inputs in one device flexible, which can be flexibly combined.

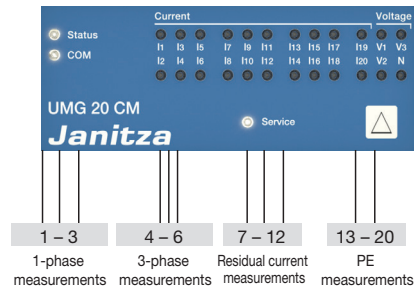

Fig. case 5: 3 single-phase operating current measurements, 1 three-phase operating current measurements, 6 single-phase residual current measurements, 8 single-phase PE measurements

Customer benefits:

Flexible combination of 1-phase and 3-phase measurements as well as operating current and RCM measurement in a single measurement device.

Functional description

General functions

Principle of residual current monitoring

Residual currents can be measured with current transformers via every channel of the UMG 20 CM. The residual currents flowing to ground or any other path are acquired, e.g.:

- residual currents in supplies
- residual currents with consumers and systems
- stray currents TN-S systems (PEN and N conductor)
- residual currents at central ground points

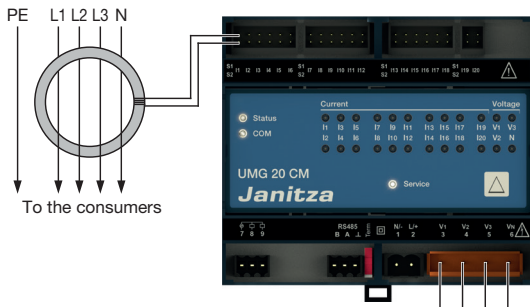

Fig. Simplified representation of residual current measurement

Principle of operating current monitoring

Depending on the type of the current transformer, operating currents can be measured via every channel of the UMG 20 CM.

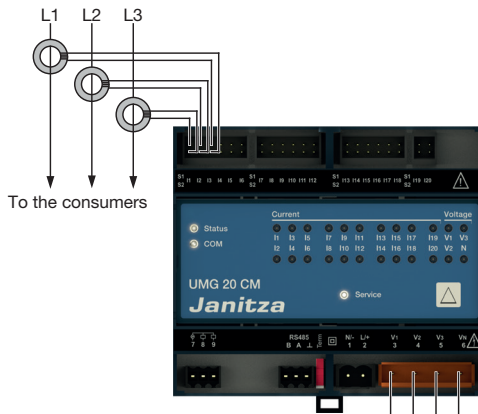

Fig. Simplified representation of operating current measurement

Current monitoring at central ground points



Caution!

The operating current transformers that are designed for the currents to be expected must be used for measuring the current at the central ground points.

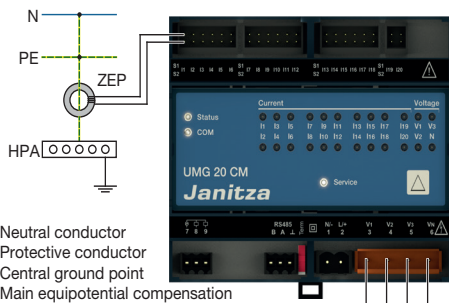

Fig. Simplified representation of the current monitoring at the central ground point

Monitoring the current transformer

The UMG 20 CM analyses up to 20 current transformers simultaneously. The transformer connection is monitored for each connected transformer.

When measuring residual current, an interruption and a short circuit are detected in the current circuit from the current measurement input and transformer.

When measuring operating current, an interruption of the current circuit is detected from the measurement input and load resistance.

If a connection fault occurs, an error message is displayed via the LEDs (see section “Meaning of the LEDs” on page 36).



Note!

The connection monitoring of current inputs that are not used must be deactivated.

Residual and operating current monitoring parameters

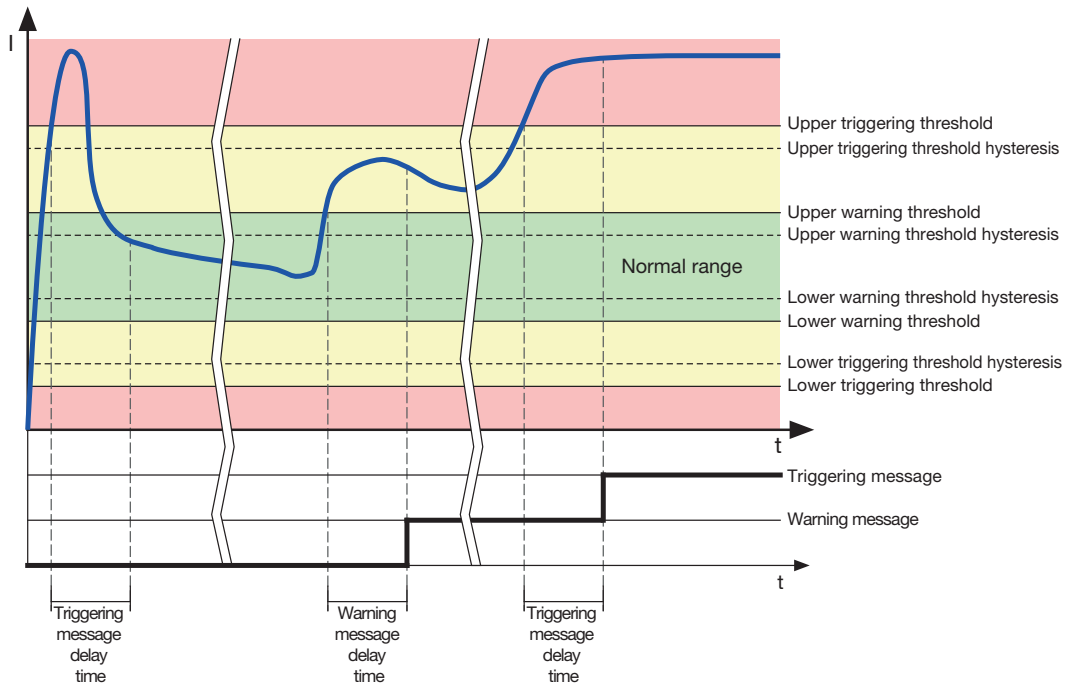

Warning and triggering thresholds

Warning and triggering thresholds are configurable threshold values, which can be adjusted to the currents to be monitored. They can be configured separately for each channel.

Warning and triggering messages are sent once these threshold values are reached. The measuring channels LEDs signal when the values are below or exceed the respective threshold values (see section “Meaning of the LEDs” on page 36).

Hysteresis

Warning and triggering threshold values have a configurable hysteresis. They can be individually defined for each channel and apply to the warning and triggering threshold.

If the measured residual or operating current, for example, exceeds the upper triggering threshold and decreases again, the triggering message is only reset after the value is below the hysteresis of the upper triggering threshold and the configured reset delay time.

Delay times of the warning and triggering messages

By configuring the delay times for warning and triggering messages, messages indicating values falling under and exceeding the limit value over the short-term are hidden. They are only displayed after the delay time expires and the current characteristic is still always above the upper threshold or below the lower threshold.

The delay times can be set separately for each measuring channel.

Reset delay time of the triggering and warning messages

If there are no other pending messages, the UMG 20 CM resets the warning and triggering messages. The reset delay time of the triggering and warning messages can be configured and is necessary to bypass brief fluctuations. It applies to all measuring channels of a UMG 20 CM equally.

Messages are only reset after the reset delay time expires if the current characteristic falls below/exceeds the hysteresis of the upper/lower triggering or warning threshold.

Measuring function

The UMG 20 CM measures the effective values of the L-N star voltages and the L-L outer conductor voltages. The effective value measures apparent power I , effective power P and active energy W for each current channel.

The following is calculated from this:

- Apparent power $S = U * I$

- Reactive power $Q = \sqrt{S^2 - P^2}$

- Power factor $K = \frac{P}{S}$

- Power factor of the basic oscillation $\cos(\varphi) = \frac{P1}{S1}$

The UMG 20 CM measures the quantity and phase angle of the basic oscillation for all voltages and currents. The quantity is specified as an effective value.

The angles of all voltage channels refer to the star voltage $U1$ (L1-N). The phase angle of a current channel refers to the voltage channel assigned to it.

A phase angle is positive if the measured variable leads the reference parameters. A positive angle for a current channel indicates a capacitive load.

In addition to the phase angle ϕ of a current channel, the device also calculates the $\cos(\phi)$. It determines the following from the development of the current over a period of time:

- Crest factor $K_s = \frac{I_s}{I}$ with peak value of the current I_s

- Harmonic content $H_n = \frac{I_n}{I} * 100$ with effective value of the harmonics I_n for $n=1...63$

- Harmonic distortion $K_f = \frac{\sqrt{\sum_{n=2}^{63} I_n^2}}{I}$

This characteristic data is determined using an analysis channel that can be programmed on each current or voltage channel ($U1, U2, U3, U2-U1, U3-U2, U1-U3$).

The UMG 20 CM has seven aggregating channels with which the effective power and active energy of any current channels can be added.

Transformer connection monitoring

The UMG 20 CM measures and monitors the ohmic resistance at each transformer connection. It usually comprises the parallel connection of the copper resistance of the secondary coil and the load resistance. If the transformer does not deliver any secondary current and the resistance is within the target range, the UMG 20 CM reports a connection error.

If only the transformer is connected to a current transformer connection and not the load resistance (residual current measurement), the target range covers approximately 3Ω to 20Ω . As a result, the monitoring reacts to a wire breakage and short circuit. If there is a load resistance, the monitoring only reacts to the wire breakage.

Limit value monitoring

The UMG 20 CM monitors the limit value for all apparent currents that can be set using the following parameters:

- Overcurrent triggering thresholds
- Overcurrent warning threshold
- Undercurrent warning threshold
- Undercurrent triggering threshold
- Hysteresis for warning and triggering thresholds
- Delay time of the warning and triggering messages
- Reset delay time of the triggering and warning messages

If a current exceeds the overcurrent triggering threshold for the duration of the triggering delay, the device outputs an overcurrent triggering message. If the current then falls below this threshold for the duration of the reset delay (overcurrent triggering threshold - hysteresis), the device resets the message.

If a current is below the undercurrent triggering threshold for the duration of the triggering delay, the device outputs an undercurrent triggering message. If the current then exceeds the value for the duration of the reset delay (undercurrent triggering + threshold hysteresis), the UMG 20 CM resets the message.

The warning messages for overcurrent and undercurrent are generated based on the set overcurrent and undercurrent warning thresholds in the same manner.

The aggregating channels also deliver these four threshold value messages. If, for example, the overcurrent triggering message of an aggregated current channel is set, the UMG 20 CM delivers an overcurrent triggering message for the aggregating channel.

Storing extreme values

The UMG 20 CM stores the occurring minimum and maximum values for each current channel:

- Apparent power
 - Effective power
- with time stamp.

The stored extreme values are reset channel by channel by commands, e.g. via Modbus®. The UMG 20 CM clock, which has a battery backup, can be set via Modbus®.

Installation

Position of installation

The UMG 20 CM can be installed in switch cabinets or in the small installation distributors according to DIN 43880.

It can be installed in any mounting position.

Mounting

It is assembled on a 35 mm top-hat rail in accordance with DIN EN 60715. The device is fastened on the rear using a top-hat rail clip.

Installation

Supply voltage

The UMG 20 CM requires supply voltage to operate. The type and amount of the supply voltage required is specified on the rating plate.

**Note!**

Before connecting the supply voltage, ensure that the voltage and frequency correspond to the details on the ratings plate!

The connection cables for the supply voltage must be protected using a UL listed fuse (6 A type C).

**Caution!**

- If installed in a building, a disconnector or circuit breaker must be provided for the supply voltage.
- The disconnector must be installed near the device and easily accessible to the user.
- The switch must be marked as the circuit breaker for this device.
- Voltages which are over the permitted voltage range can destroy the device.

**Caution!**

Devices that can be supplied with DC current are protected against reverse polarity.

**Warning!**

The inputs for the supply voltage are hazardous if touched!

Voltage measurement inputs

The UMG 20 CM has three voltage measurement inputs (V1, V2, V3).

Overvoltage:

The voltage measurement inputs are suitable for use in networks where overvoltages of overvoltage category III (300 V CAT III, rated impulse voltage 4 kV) can occur.

Frequency:

For the measurement and calculation of measured values, the device needs the network frequency. It is suitable for measurements on systems in a frequency range from 45 to 65 Hz.

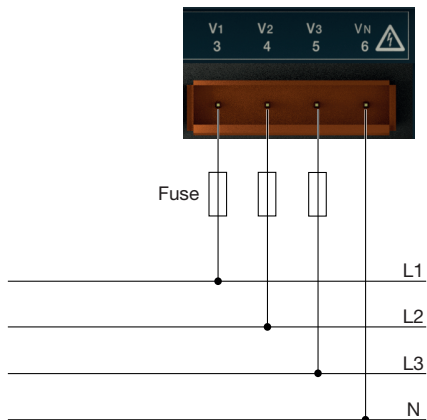

Fig. Example connection for measuring voltage

When connecting the voltage to be measured, the following must be observed:

- A suitable isolation device must be fitted to disconnect and de-energise the UMG 20 CM.
- The isolation device must be placed in the vicinity of the UMG 20 CM and marked for the user and easily accessible.

- A UL/IEC approved circuit breaker 10 A (Type C) must be used for the overcurrent protection and isolation device.
- The overcurrent protection must have a rated value, which is suitable for the short circuit current at the connection point.
- Measured voltage and measured currents must derive from the same network.



Caution!

The UMG 20 CM is not suitable for measuring DC voltages.



Warning!

- The voltage measurement inputs are dangerous to touch!
- The current measurement inputs may only be touched when the earth terminal of the RS485 interface is connected. Otherwise, there is a risk of an electrical shock. (Touch voltage up to approx. 175 V and current less than 0.5 mA)

Voltage and current measurement

The following drawings display the connection of the UMG 20 CM measuring inputs (without the current transformer's load resistances).

The displayed earthed systems may have a L-N rated voltage of max. 230 V.

The systems displayed without neutral conductors may include IT networks, provided a L-L rated voltage of 230 V is not exceeded.

An IT network with high impedance is connected to the earth by the device's voltage measurement inputs. If an insulation monitoring device is installed in the IT network, its triggering value must be set corresponding low. The internal resistance of the UMG 20 CM voltage measurement inputs is measured by the insulation monitoring device as an insulation fault. Each three-phase UMG 20 CM unit connected to the IT network creates a resistance of 440 k Ω against earth. With a single-phase connection, the resistance is 660 k Ω . The polarity of a current transformer must be changed for an Aron circuit. The polarity can be changed by the current transformer's connection cables. Alternatively, the conductor can be routed in the opposite direction through the current transformer for current transformers equipped with pre-assembled connection cables.

The voltage measurement in the UMG 20 CM is designed for the overvoltage category 300 V CAT III (rated impulse voltage 4 kV).

The UMG 20 CM is intended for the connection of current transformers with secondary currents of 100 mA with load resistances. Only AC currents can be measured, however, DC currents cannot.

In case of a fault, the current measurement inputs may be loaded with a continuous current of 1 A.



Caution!

- Measured voltage and measured currents must derive from the same network.
- The used channels of the current transformer strips CT20 must be connected to the operating current measurement (OC).

Connection in three-phase 4-core systems

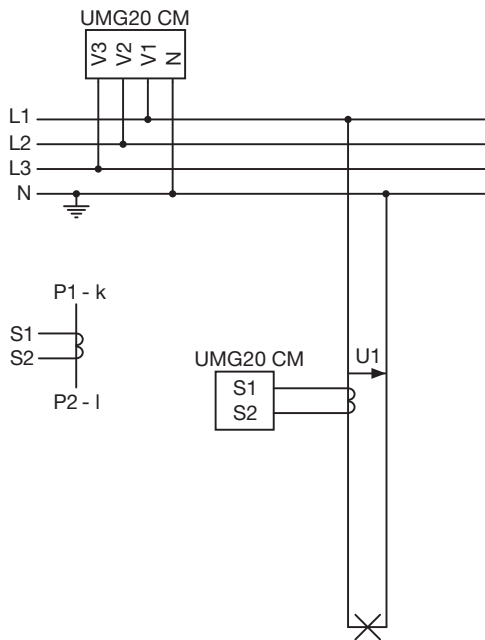

Fig. connection variant 1 (TN network)

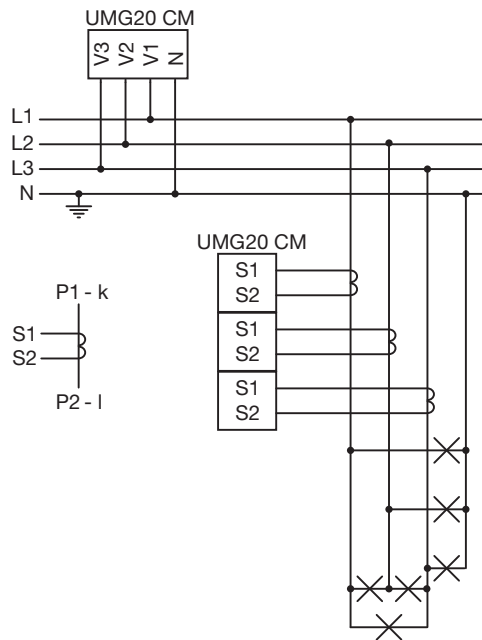

Fig. connection variant 2 (TN network)

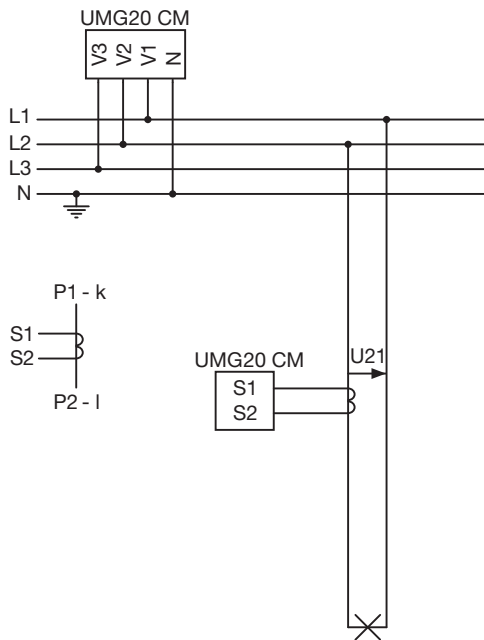

Fig. connection variant 3 (TN network)

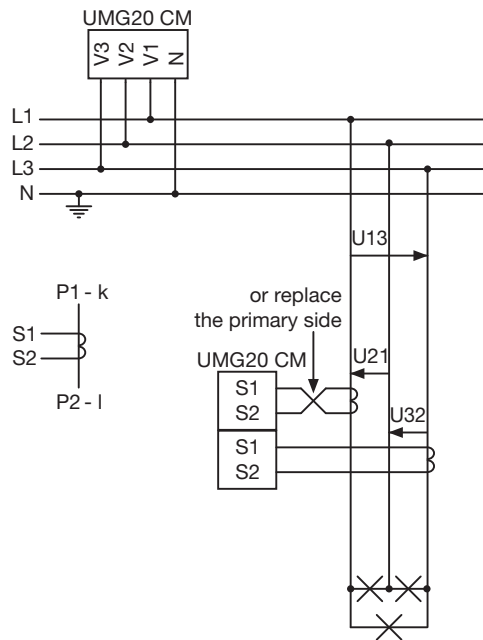

Fig. connection variant 4 (TN network)

Connection in three-phase 3-core systems

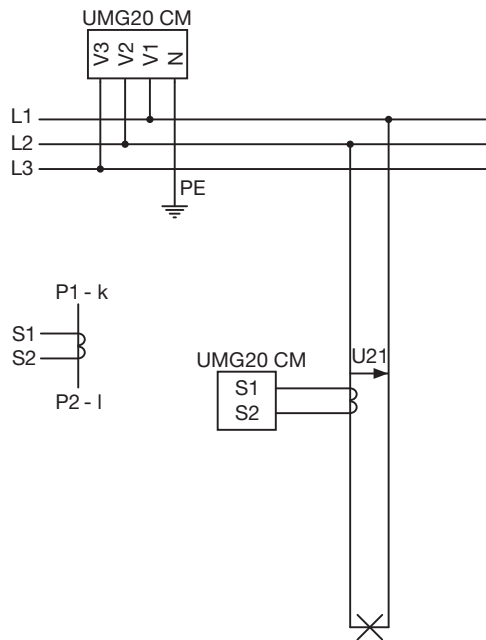

Fig. connection variant 1 (IT network)

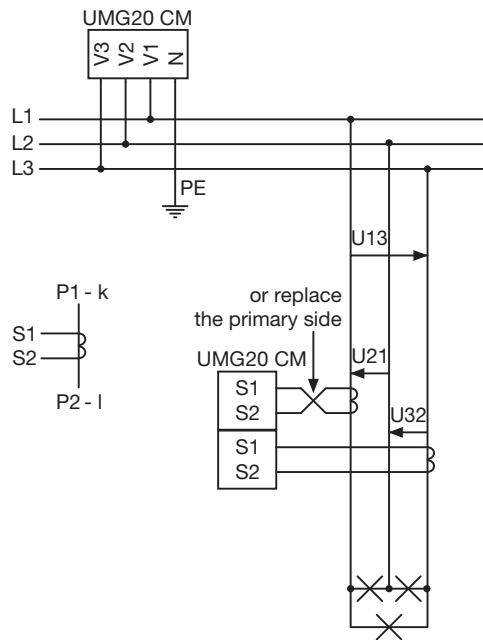

Fig. connection variant 2 (IT network)

Connection in single-phase systems

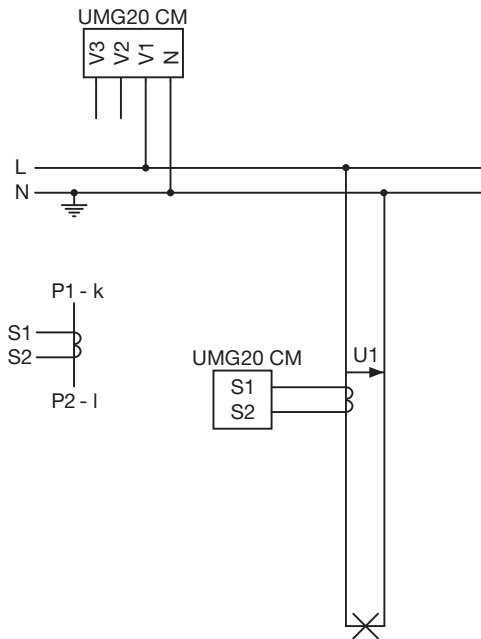

Fig. connection variant 1 (TN network)

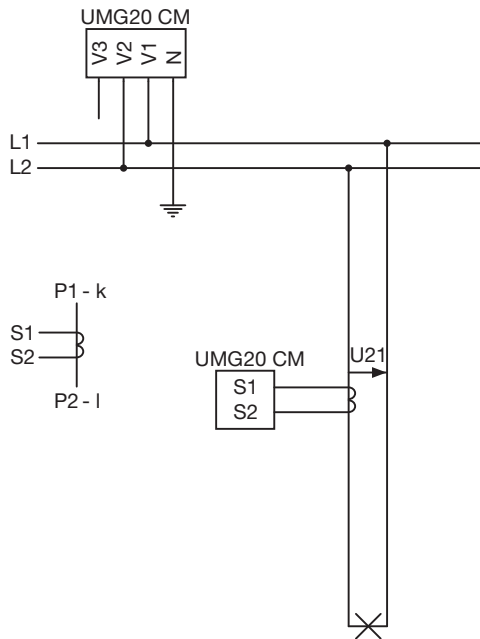

Fig. connection variant 2 (IT network)

Residual current measurement



Caution!

The used channels of the current transformer strips CT20 must be connected to the residual current measurement (RCM). Other residual current transformers must be connected without a resistance directly to the UMG 20 CM.



Warning!

The current measurement inputs may only be touched when the earth terminal of the RS485 interface is connected. Otherwise, there is a risk of an electrical shock. (Touch voltage up to approx. 175 V and current less than 0.5 mA)

RS485 interface

The UMG 20 CM has a RS485 interface and operates with the Modbus® RTU protocol. The device is factory set to address 1 and the baud rate of 19200.

Bus structure

Devices are connected in a bus structure (in a line). Up to 32 subscribers can be connected together in a single segment. If the necessary data volume of the bus participants is too large, the number of the participants must be reduced (recommendation: The bus should not contain more than 10 devices, type UMG 20 CM if several UMG 20 CM measuring channels are used. If the app “20CM-Webmonitor” is used, the number is limited to 5 devices due to the app management) The cable is terminated with resistors at the beginning and at the end of a segment. With more than 32 subscribers, repeaters (amplifiers) must be used to connect the individual segments.

Termination resistors

The cable is terminated with resistors (120 Ω ¼ W) at the beginning and at the end of a segment. The UMG 20 CM has a termination resistor. It can be connected by sliding up the switch for the bus connection resistor.

Screening

Twisted screened cable should be used for connections via the RS485 interface. To achieve a sufficient screening effect, the screening must be connected over a generous area at the end of the cable with earthed housing or cabinet parts.

Connection

The twisted cable cores must be connected to the terminals "B" and "A". To compensate potential differences between several UMG 20 CM units, the earth terminals of devices must be interconnected on the bus. The second twisted core pair of the bus cable is used for the potential equalisation. Both cores must be connected to each earth terminal. The earth line from both cores must be connected at the end of the bus cable to the PE.



Warning!

The supply connection and the voltage measurement inputs of the UMG 20 CM may only be connected after the earth terminal and ground of the earth line are connected.

Otherwise, there is a risk of an electrical shock. (Touch voltage up to approx. 175 V and current less than 0.5 mA)

Cable type

Unitronic Li2YCY(TP) 2x2x0.22 (from Lapp Kabel)

Cable length

1200 m at a baud rate of 38.4 kBaud

Digital outputs

The UMG 20 CM has two transistor switching outputs. These outputs are galvanically separated from the analysis electronics using optocouplers.

- The digital outputs can switch AC or DC loads.
- The digital outputs can switch loads, independently of the supply voltage polarity.
- The digital outputs are not short-circuit proof.
- Cables that are longer than 30 m must be shielded when laid.



Caution!

The digital outputs are not short-circuit proof.

Putting into service

RS485 interface

To ensure that the UMG 20 CM safely functions on the RS485-Bus, the following requirements must be met:

- Bus connection resistors must be fitted on both ends of the bus segment.
- The earth terminals of all RS485 connections of several UMG 20 CM units must be connected to the earth line of the cable.
- The earth line must be earthed at one location.
- The second twisted core pair of the bus cable is used as the potential equalisation. The two cores of the pair are operated connected in parallel.

Applying the measuring-circuit voltage

After applying the measured voltages (230 V L-N and 400 V L-L), the LEDs in the "Voltage" field illuminate green.

The exact display of the LEDs depends on the connection the voltage measurement inputs or the measured system:

- Earthed three-phase, 4-conductor system with 230 V L-N: The "V1", "V2" and "V3" LEDs illuminate green.
- Earthed three-phase 3-conductor system with 400 V L-L: The "V1", "V2" and "V3" LEDs illuminate green.
- Earthed single-phase system with 230 V L-N: "V1" LED illuminates green with breaks.
The "V2" and "V3" LEDs illuminate red.

With unearthed systems, it may be necessary to configure the voltage monitoring limit values from 400 V L-L to 230 V L-L.

In case of incorrect limit values, the "V1", "V2" and "V3" LEDs illuminate red.

If the limit values are correctly configured, the following displays are output:

- Unearthed three-phase 3-conductor system with 230 V L-L:
The "V1", "V2" and "V3" LEDs illuminate green.
- unearthed single-phase system with 230 V L-L:
The "V1" and "V2" LEDs illuminate green with breaks.
"V3" LED remains red.



Warning!

If the "N" LED illuminates yellow after applying the measured voltages, the earth terminal of the RS485 connection is not connected to the PE.

There is a risk of an electrical shock when touching:

- Current transformer connections
- RS485 connection

For troubleshooting, proceed as with the installation of the RS485 interface (see section "Configuration" on page 40).

Connecting the supply voltage

- The amount of the UMG 20 CM supply voltage must match the specification on the rating plate.
- After applying the supply voltage, the "Status" LED flashes green for several seconds. Once the device is operational, the "Status" LED permanently illuminates green.
If there is no measurement voltage on the device, the LEDs in the "Voltage" field illuminate red with breaks.



Warning!

If the "N" LED illuminates yellow after applying the measured voltages, the earth terminal of the RS485 connection is not connected to the PE.

There is a risk of an electrical shock when touching:

- Current transformer connections
- RS485 connection

For troubleshooting, proceed as with the installation of the RS485 interface (see section "Configuration" on page 40).

Display and control elements

General meaning of the LED colours and signals

Colour	Meaning
Green	Normal mode: no irregularities on the system or device
Yellow	Warning message: Check necessary, system and device are ready for operation again
Red	Triggering message: Function of system or device can be adversely affected

Meaning of the LEDs

LED	Colour	Signal	Meaning
Status	Green	Lights	Device is operational
		Flashing 1 Hz	Start process of the device is running – measurement values are not yet available
	Red	Lights	Device fault
	Off	-	Device has no supply voltage or is defective
COM	Green	Brief flashing	Modbus® request is successfully answered If requests are continuously sent, the light changes from briefly flashing to solid.
	Red	Brief flashing	Invalid Modbus® request (CRC, unknown function) If requests are continuously sent, the light changes from briefly flashing to solid.

LED	Colour	Signal	Meaning
COM	Red	Lights	Violation of the Modbus® protocol: Request with too many bytes received OR two requests are received consecutively without having issued an answer
	Off	-	No Modbus® activity
Service	Off	-	Normal mode
	Yellow	Lights	Device address input active
	Green	Brief flashing	Input confirmation for button code
Voltage V1..V3	Red	Flashing 1 Hz	Measuring amplifier fault
		Flashing 4 Hz	Measuring range exceeded
		Lights	Star voltage too high
		Lights with breaks	Star voltage is too low
	Green	Lights with breaks	Star voltage OK, outer conductor voltage too low Example: Lights V1 and V2 are green with breaks, the U2- U1 voltage is missing.
		Lights	Star voltage and outer conductor voltage OK
Voltage N	Off	-	Normal mode
	Yellow	Lights	Earth connection of the RS485 interface not connected

LED	Colour	Signal	Meaning
Current 1...20	Red	Flashing 1 Hz	Transformer connection fault or measuring amplifier fault
		Flashing 4 Hz	Measuring range exceeded
		Lights	Overcurrent triggering message
		Lights with breaks	Undercurrent triggering message
	Yellow	Lights	Overcurrent warning message
		Lights with breaks	Undercurrent warning message
	Green	Lights	Address currently selected for entering the device address
		Lights with breaks *	Current is in the target range Undercurrent warning threshold < current < overcurrent warning threshold The lighting time approximately signals the level of the flowing current.
		Off	-

* Lighting duration increases with increasing current levels

The service button functions

The UMG 20 CM functions are directly triggered by the service button.

The button is pressed via button codes and similar Morse code. They are defined in the adjacent table as follows:

.	Short press (< 0.3 s)
-	Long press (> 0.3 s)



Note!

When entering button codes, no more than 1 second may elapse between entering codes.

A button code entry is confirmed if the "Service" LED briefly illuminates green once.

Button code	Function
- -	Sets the device address
. . .	Restarts the device
- - - . .	Loads the device default settings (in the volatile memory)
. . - . .	Saves the current settings in the non-volatile memory

Configuration

RS485 interface

The default settings for the RS485 interface and the Modbus® RTU protocol are as follows:

- 19200 baud
- Device address 1

Entering the device address on the UMG 20 CM

Variant 1:

1. Press the service button in intervals – – (twice long).
The "Service" LED illuminates yellow.
The corresponding "Current" LED illuminates green on the current device address.
2. Select new device address. To do this, briefly press the Service button.
Each time the button is pressed, the "Current" LEDs are selected step by step according their addresses 1 through 20.
3. Save the new device address. To do this, press the Service button for at least 2 s.
The "Service" LED goes out.
Note: If the Service button is not pressed within 10 s, the new device address is not saved. The "Service" LED goes out.

Variant 2:

If only device types UMG 20 CM are connected as a Modbus® slave in the bus segment and if the device address 1 has not yet been assigned, you can proceed as follows:

1. Disconnect all UMG 20 CM device types from the supply voltage.
As a result, the devices no longer function as a bus subscriber.
2. Switch on the power supply of a UMG 20 CM.
3. Add the device according to the default settings in the GridVis programming software.
4. Set the device to the desired device address and, if necessary, the baud rate.
5. Repeat steps 2 to 4 for all other devices of type UMG 20 CM.

Technical data

UMG 20 CM technical data

General information	
Item no.:	14.01.625
Type of measurement	Continuous real effective value measurement up to the 63rd harmonic
Operating voltage	90 ... 276 V AC and DC
Measurement in quadrants	4
TN, TT, IT networks	TN, TT, IT
Measurement in single-phase/multi-phase networks	1 ph, 2 ph, 3 ph and up to 20 times 1 ph

Measured voltage input	
Overvoltage category	300 V CAT III
Measured range, voltage L-N, AC (without transformer)	10 ... 300 Vrms
Measured range, voltage L-L, AC (without transformer)	10 ... 480 Vrms
Resolution	0.1 V
Impedance	1.3 M Ω / phase
Frequency measuring range	45 ... 65 Hz
Sampling frequency	20 kHz / phase

Measured current input	
Evaluation range of the operating current	0 ... 63 A (600 A) *
Evaluation range of the residual current	10 ... 1000 mA
Resolution	1 mA
Cut-off frequency	3.2 kHz
Relative deviation	+/- 1%

*Caution: Available with firmware 8.0 and higher

Monitoring function	
Response function	0...650 s
Reset delay	0...650 s
Triggering the delay	10 ms

Digital inputs and outputs	
Number of digital outputs	2
Switching voltage	max. 60 V DC, 30 V AC
Maximum current	350 mA
Switch-on resistance	2 Ω
Maximum line length	up to 30 m unscreened, from 30 m screened

Mechanical properties	
Weight	270 g
Device dimensions in mm (H x W x D)	90 x 105 x approx. 73
Protection class per EN 60529	IP20
Assembly per IEC EN 60999-1 / DIN EN 50022	35-mm DIN top-hat rail

Environmental conditions	
Temperature range	Operation: K55 (-10 °C ... +55 °C)
Relative humidity	Operation: 5 ... 95% (at 25 °C)
Operating altitude	0 ... 2000 m above sea level
Degree of pollution	2
Mounting position	any

Electromagnetic compatibility	
Electromagnetic compatibility of equipment	Directive 2004/108/EC
Electrical equipment for use within certain voltage limits	Directive 2006/95/EC

Equipment safety	
Safety requirements for electrical equipment for measurement, control, and laboratory use	
Part 1: General requirements	IEC/EN 61010-1
Part 2-030: Particular requirements for testing and measuring circuits	IEC/EN 61010-2-030

Immunity from interference	
Class A: Industrial area	IEC/EN 61326-1
Electrostatic discharge	IEC/EN 61000-4-2
Voltage drops	IEC/EN 61000-4-11

Emissions	
Class B: Residential area	IEC/EN 61326-1
RFI field strength 30 ... 1000 MHz	IEC/CISPR11/EN 55011
Radiated interference voltage 0.15 ... 30 MHz	IEC/CISPR11/EN 55011

Safety	
Europe	CE labelling

Function parameters

Function	Symbol	Precision class / relative measuring deviation	Measurement range
Total effective power	P	1 (EN61557-12)	-655 kW .. +655 kW ¹⁾
Effective power for outer conductor p	Pp	1 (EN61557-12)	-32.7 to +32.7 kW ¹⁾
Total reactive power	QA, QV	-	-
Reactive power for outer conductor p	Qp	1 (EN61557-12)	0 to 32.7 kvar ¹⁾
Total apparent power	SA, SV	-	-

Function	Symbol	Precision class / relative measuring deviation	Measurement range
Apparent power for outer conductor p	Sp	1 (EN61557-12)	0 to 32.7 kVA ¹⁾
Total active energy	Ea	1 (EN61557-12)	-42.9 .. +42.9 GWh ¹⁾
Effective energy for outer conductor p	Ep	1 (EN61557-12)	-2.29 .. +2.29 GWh ¹⁾²⁾
Total reactive power	ErA, ErV	-	-
Total apparent energy	EapA, EapV	-	-
Frequency	f	0.05 (EN61557-12)	45 .. 65 Hz
Phase current	I	1 (EN61557-12)	0 .. 63 Arms ¹⁾
measured neutral current	IN	1 (EN61557-12)	0 .. 63 Arms ¹⁾
Residual current	IDiff	+2 %	2 .. 1000 mArms
Voltage	UL-N (Vp)	1 (EN61557-12)	10 .. 300 Vrms
Voltage	UL-L (Up _g)	1 (EN61557-12)	10 .. 520 Vrms
Total power factor	PFA, PFV	-	-
Power factor for outer conductor p	PFp	1 (EN61557-12)	-1 .. +1
Short-term/long-term flicker	Pst, Plt	-	-
Voltage drops	Udip	-	-
Voltage increases	Uswl	-	-
Transient overvoltage	Utr	-	-

Function	Symbol	Precision class / relative measuring deviation	Measurement range
Voltage interruption	Unit	-	-
Voltage unbalance	Unba	-	-
Voltage unbalance	Unb	-	-
Voltage harmonics	Uh/U	+2 %	0 .. 100%, to 1.8 kHz ³⁾
THD of the voltage	THDu	-	-
THD of the voltage	THD-Ru	+2 %	0 .. 100%
Current harmonics	Ih/I	+2 %	0 .. 100%, to 1.8 kHz ³⁾
THD of the current	THDi	-	-
THD of the current	THD-Ri	+2 %	0 .. 100%
Mains signal voltage	Msv	-	-

1) The information applies to operation with a current transformer load combination with a measuring range of 63 A.

2) When the maximum values are reached, the display jumps to the opposite end of the measuring range.

3) Larger measurement deviations must be expected above the specified frequency.

With 3.2 kHz, up to +-20% can occur.

Technical data for the usable current transformer

Divisible residual current transformer type A

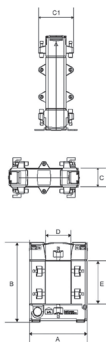

Type	Transformer ratio	Max. primary residual current [mA] *	Dimension [mm]					Item no.
			A	B	C / C1	D	E	
KBU 23D	600/1	1000	93	106	34/58	20	30	15.03.400
KBU 58D	600/1	1800	125	152	34/58	50	80	15.03.401
KBU 812D	600/1	1800	155	198	34/58	80	120	15.03.402

* When using the analogue inputs of the UMG 20 CM

Current transformer CT-20 class 1



Type	Max. operating current [A]	Residual current [mA]	Transformer ratio	Max. primary conductor diameter [mm]	Class	Dimension [mm] (H x W x D)	Weight [kg]	Item no.
CT-20	63 (with load)	10 ... 1000	700/1	7.5	1	approx. 46 x 27 x 23	0.05	15.03.082
Accessories								
Snap fastening for top-hat rail EN 50022-35, suitable for type CT-20						approx. 14 x 41 x 27	approx. 0.1	09.09.010
Ready-made connection cable 1.5 m with load for operating current measurement								15.03.085

Split-core current transformer SC-CT-20 and SC-CT-21



Type	Operating mode	Max. operating current [A]	Residual current [mA]	Transformer ratio	Max. primary conductor diameter [mm]	Precision [%]	Dimension [mm] (H x W x D)	Weight [kg]	Item no.
SC-CT-20	Operating current measurement*	63	-	3000/1	10	1	approx. 41 x 32 x 32	0.04	15.03.092
SC-CT-21	Residual current measurement	-	10 ... 1000	700/1	8	1	approx. 35 x 35 x 16	0.05	15.03.084
Individual accessory (load is included the scope of the SC-CT-20 delivery)									
Load (3.9 Ω) for operating current transformer SC-CT-20 with 1.5 m connection cable and spring terminal									15.03.086

* Incl. ready-made connection cable; 1.5 m with load for operating current measurement

6-fold top-hat rail current transformer strip CT-6-20 (operating and residual current transformer type A)

Type	Operating mode *	Operating current with load [A]	Residual current [mA]	Number measuring channels **	Transformer ratio	Precision [%]	Internal transformer diameter [mm] ***	Dimension [mm] (H x W x D)	Weight [kg]	Item no.
CT-6-20	Residual or operating currents	0...63	10...1000	6	700/1	1	11	56 x 174 x 45	0.3	14.01.630
Accessories										
Ready-made connection cable 1.5 m twisted, screened with connector										08.02.440

* Preconfigurable as needed via dip switch

** Integrated measuring transducer

*** For maximum 4 x 6 mm² cable

Divisible operating current transformer up to 600 A

Type	Operating mode	Max. operating current [A]	Transformer ratio	Max. primary conductor diameter [mm]	Precision [%]	Dimension [mm] (H x W x D)	Item no.
SC-CT-20-100	Operating current measurement *	100	3000/1	16	1	55 x 29.5 x 31	15.03.093
SC-CT-20-200	Operating current measurement *	200	3000/1	24	1	74.5 x 45 x 34	15.03.094
SC-CT-20-300	Operating current measurement *	300	3000/1	24	1	74.5 x 45 x 34	15.03.095
SC-CT-20-400	Operating current measurement *	400	4000/1	36	0.5	91 x 57 x 40	15.03.097
SC-CT-20-500	Operating current measurement *	500	5000/1	36	0.5	91 x 57 x 40	15.03.099
SC-CT-20-600	Operating current measurement *	600	6000/1	36	0.5	91 x 57 x 40	15.03.101
Individual accessory (load is included the scope of the transformer delivery)							
Load (2.2 Ω) for operating current transformer SC-CT-20-100 with 1.5 m connection cable and spring terminal							15.03.087
Load (1.1 Ω) for operating current transformer SC-CT-20-200 with 1.5 m connection cable and spring terminal							15.03.088
Load (0.8 Ω) for operating current transformer SC-CT-20-300/400/500/600 with 1.5 m connection cable and spring terminal							15.03.085

* Incl. ready-made connection cable; 1.5 m with load and spring terminal for operating current measurement

Declaration of conformity

The UMG20CM meets the requirements of the following directives and standards:

Equipment safety according to:

- "Low-Voltage Directive" 2006/95/EC
- EN 61010-1:2011 "Safety requirements for electrical equipment for measurement, control, and laboratory use"
- EN 61010-2-30:2011 "Particular requirements for testing and measuring circuits"

Electromagnetic compatibility according to:

- Directive 2004/108/EC "EMC Directive"
- EN 61000-6-2:2005 "Generic standards - Immunity for industrial environments"
- EN 61326-1:2006 "Requirements for electrical equipment for measurement, control, and laboratory use"
- EN 55011:2009:2010 "Emitted interference for industrial, science and medical equipment"
- EN 55022:2010 "Emitted interference for information technology equipment"
- EN 55024:2010 "Immunity for information technology equipment"
- EN 50121-4:2006 "Requirements for signalling and telecommunications equipment for railway applications"

The emitted interference of the device meets the requirements for limit class B for use in living environments. The immunity meets the requirements for the industrial sector.

Emissions

Conducted interference

Test conditions

150 kHz – 30 MHz

Conducted interference current

150 kHz – 30 MHz

RFI field strength

30 MHz – 2 GHz

Immunity from interference

Test conditions

Electrostatic discharge

8 kV Air discharge

4 kV Contact discharge

Electromagnetic HF field

80 MHz – 2.7 GHz, 10 V/m

0.8 – 1 GHz, 20 V/m

Rapid transients

2 kV

Surge voltages

1 kV, conductor-conductor, 1.2/50 μ s

2 kV, conductor-earth, 1.2/50 μ s

Conducted interferences

150 kHz – 80 MHz, 10 V

Magnetic fields with frequencies specific to power engineering

50 – 60 Hz, 30 A/m

Voltage drops

Drop to 0 V : 20 ms

Drop to 40 V : 200 ms

Brief instruction



Warning!

The connection sequence must be observed!

The RS485 interface must first be connected to the UMG 20 CM.

Otherwise, there is a risk of electrical shock on the B and A terminals of the RS485 interface. (Touch voltage up to approx. 175 V and current less than 0.5 mA)

Connection sequence:

1. Connect the RS485 interface.
2. Connect the current measurement transformer.
3. Connect the current measurement conductor.
4. Connect the power supply.
5. Configure the device.

1. Connect the RS485 interface

The device is factory set to address 1 and the baud rate of 19200.

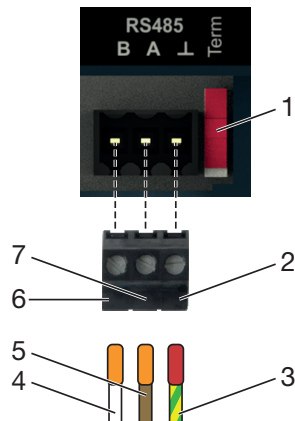

Fig. RS485 interface connection

- | | |
|---------------------------------------|--------------------------|
| 1 Switch for bus termination resistor | 4 Conductor B |
| 2 Connection for protective conductor | 5 Conductor A |
| 3 PE protective conductor | 6 Conductor B connection |
| | 7 Conductor A connection |

Connect to the device

Establish connection (2) with the PE protective conductor (3).

If the device is the first or last device in a Modbus® line, the termination resistor must be connected by sliding up the switch for the bus connection resistor. (1).



Note!

The screening may only be installed on one side!

RS485 connection inside a switch cabinet

Devices with galvanic separation may not be connected to the earth connection!

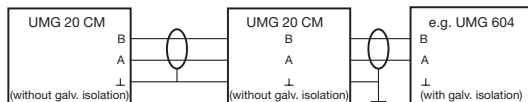

RS485 connection switch cabinet to switch cabinet

The Modbus® connections B and A must be galvanically separated.

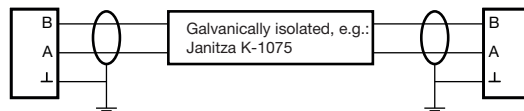

2. Current measurement inputs I1-I20

Connect the transformer to the plug terminals S1 and S2 of the respective current input (I1 to I20).

3. Voltage measurement VN, V1 – V3

Connect the neutral conductor (N) to terminal VN.
 Connect L1 to terminal V1.
 Connect L2 to terminal V2.
 Connect L3 to terminal V3.

4. Voltage supply N/- and L/+

Connect the neutral conductor (N) to terminal N/-.
 Connect L1 (or L2 or L3) to L/+.

5. Configure the device

The device can be configured using the Service button or via GridVis version 4.2 or higher.

Using the Service button

.	Short press (< 0.3 s)
–	Long press (> 0.3 s)

When entering button codes, no more than 1 second may elapse between entering codes.

A button code entry is confirmed if the "Service" LED briefly illuminates green once.

Button code	Function
– –	Sets the device address
. . .	Restarts the device
– – – . .	Loads the device default settings (in the volatile memory)
. . – . .	Saves the current settings in the non-volatile memory

Enter the device address on the UMG 20 CM:

- Press the service button in intervals – – (twice long). The "Service" LED illuminates yellow. The corresponding "Current" LED illuminates green on the current device address.
- Select new device address. To do this, briefly press the Service button. Each time the button is pressed, the "Current" LEDs are selected step by step according their addresses 1 through 20.
- Save the new device address. To do this, press the Service button for at least 2 s. The "Service" LED goes out.
Note: If the Service button is not pressed within 10 s, the new device address is not saved. The "Service" LED goes out.

Using GridVis

The identity, transformer, current monitoring, input/output configuration, time, serial interface, designation of the inputs and online recording can be configured using GridVis version 4.2 or higher.

Connection example

